

# Safety Shock Absorbers

## Perfect protection for the worst case scenario

**As a cheaper alternative to the standard shock absorber, Safety shock absorbers are the tried and tested low cost method of preventing those occasional emergency stops. Designed for occasional use, they primarily serve as reliable, effective protection in emergency stopping for construction designs.**

The maintenance-free and ready-to-install machine elements are characterised in every respect by the well-known high ACE quality and maximum energy absorption of up to 480,000 Nm/Cycle. This means, in the product family SCS33 up to SCS64 a service life of up to 1,000 full load emergency cycles is achieved. Safety shock absorbers from ACE are available in a large choice with strokes of 23 mm to 1,200 mm, and the arrangement of orifice pattern can be calculated and produced specifically to the customer's requirements and depending on the application.



## Safety Shock Absorbers



### SCS33 to SCS64

Page 250

Self-Compensating or Optimized Characteristic

**Industry design with high energy absorption**

Finishing and processing centres, Conveyor systems, Portal systems, Test stations



### SDH38 to SDH63

Page 254

High Rack Damper, Optimized Characteristic

**Low reaction forces with long strokes**

Shelf storage systems, Test stations, Heavy load applications, Conveyor systems



### SDP63 to SDP160

Page 258

Crane Installations, Optimized Characteristic

**High return forces with gas pressure accumulator**

Shelf storage systems, Heavy load applications

Top machine protection

Latest damping technology

Attractive cost-benefit ratio

Maximum traverses

Wide application spectrum

Robust design



## SCS33 to SCS64

### Industry design with high energy absorption

**Self-Compensating or Optimized Characteristic**  
**Energy capacity 310 Nm/Cycle to 18,000 Nm/Cycle**  
**Stroke 23.1 mm to 150 mm**

Effective emergency stop: The ACE safety shock absorbers from the SCS33 to SCS64 product family are based on the innovative technology of the successful industrial shock absorbers from the MAGNUM-Series. They are also maintenance-free and ready-to-install.

Due to the optimised characteristic curve for the respective application, the energy absorption of these hydraulic machine elements can be increased to more than twice the level of the MAGNUM model of ACE industrial shock absorber per stroke. Users benefit from a service life of up to 1,000 full load emergency cycles with a very good price-performance ratio. Their compact design in sizes M33x1.5 to M64x2 makes them easy to integrate into current applications.

These slimline, high-performance safety shock absorbers are only designed for emergency stop situations. They can be used for a number of tasks in gantries and conveyor systems, processing centres or assembly machines.

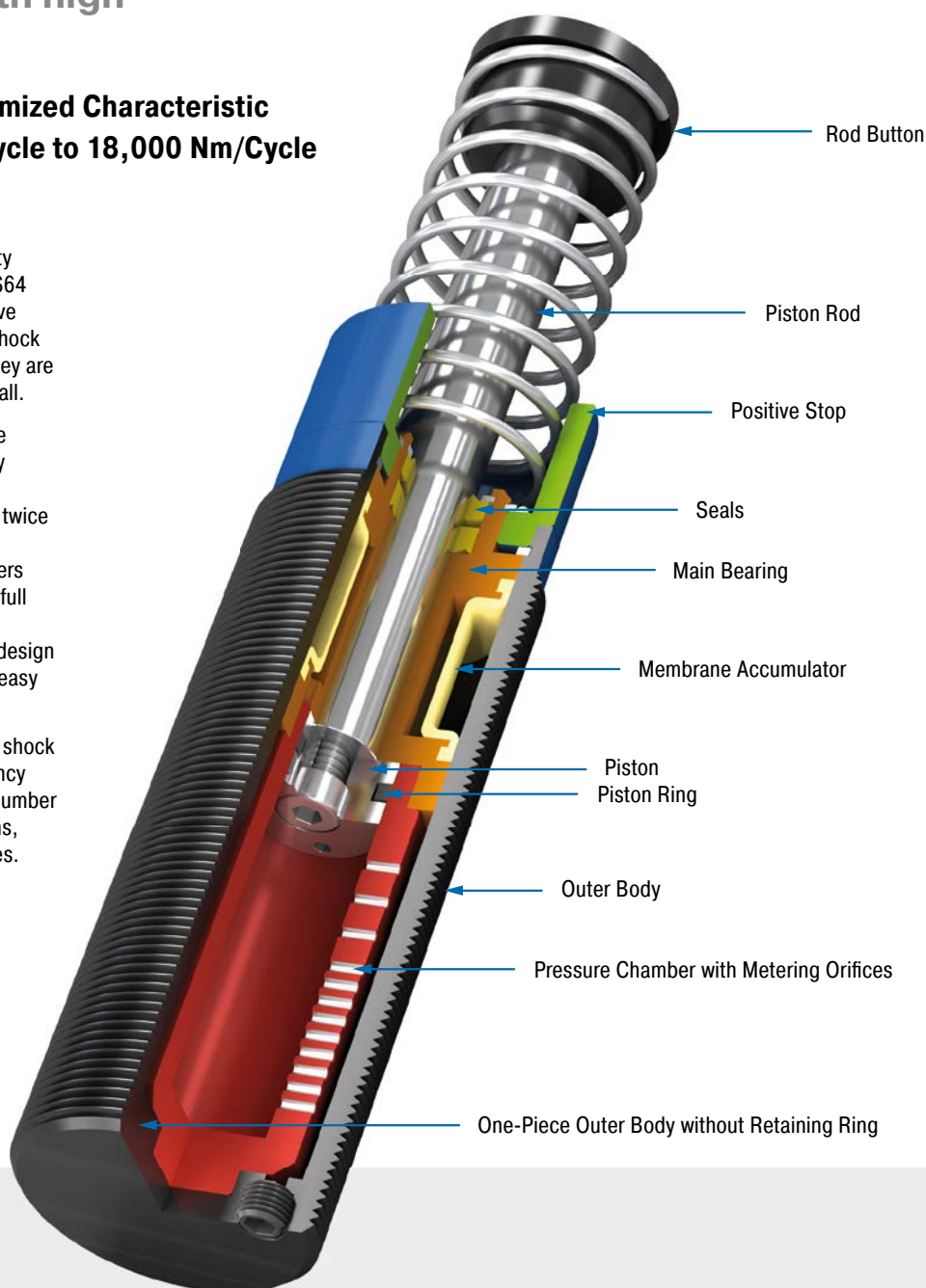

### Technical Data

**Energy capacity:** 310 Nm/Cycle to 18,000 Nm/Cycle

**Impact velocity range:** 0.02 m/s to 5 m/s.  
Other speeds on request.

**Operating temperature range:** -12 °C to +66 °C. Other temperatures on request.

**Mounting:** In any position

**Positive stop:** Integrated

**Material:** Outer body: Nitride hardened steel; Piston rod: Hard chrome plated steel; Rod end button: Hardened steel and corrosion-resistant coating; Return spring: Zinc plated or plastic-coated steel; Accessories: Steel corrosion-resistant coating

**Damping medium:** Automatic Transmission Fluid (ATF)

**Application field:** Finishing and processing centres, Conveyor systems, Portal systems, Test stations, Machines and plants, Swivel units, Cranes

**Note:** The shock absorber can be pushed through its stroke. In creep speed conditions the shock absorber provides minimal resistance and there is no braking effect.

**On request:** Special oils, special flanges etc.

**SCS33EU**

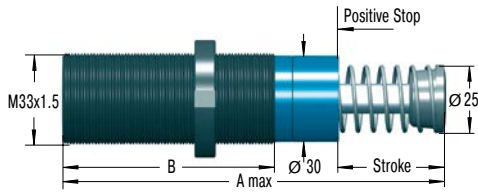

The calculation and selection of the most suitable damper should be carried out or be approved by ACE.

**Accessories**

**NM33**

Locking Ring

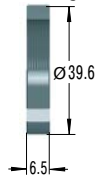

**QF33**

Square Flange

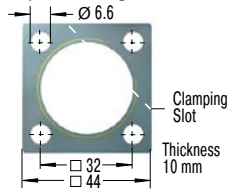

Torque max.: 11 Nm  
Clamping torque: > 90 Nm  
Install with 4 machine screws

**S33**

Side Foot Mounting Kit

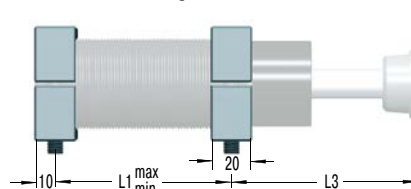

S33 = 2 flanges + 4 screws M6x40, DIN 912  
Torque max.: 11 Nm  
Clamping torque: 90 Nm

Because of the thread pitch the fixing holes for the second foot mount should only be drilled and tapped after the first foot mount has been fixed in position.

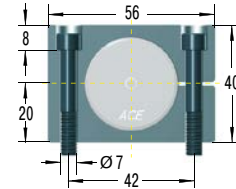

**Complete details required when ordering**

- Moving load: m (kg)
- Impact velocity range: v (m/s) max.
- Creep speed: vs (m/s)
- Motor power: P (kW)
- Stall torque factor: ST (normal, 2.5)
- (Alternatively: Propelling force F (N))
- Number of absorbers in parallel: n

or technical data according to formulae and calculations on page 265.

**Ordering Example**

**SCS33-50EU-1xxxx**

Safety Shock Absorber \_\_\_\_\_

Thread Size M33 \_\_\_\_\_

Max. Stroke without Positive Stop 50 mm \_\_\_\_\_

EU Compliant \_\_\_\_\_

Identification No. assigned by ACE \_\_\_\_\_

**Please indicate identification no. in case of replacement order**

**Performance and Dimensions**

TYPES	Max. Energy Capacity		Return Force min. N	Return Force max. N	Stroke mm	A max. mm	B mm	L1 min. mm	L1 max. mm	L3 mm	Side Load Angle max. °	Weight kg
	W <sub>3</sub> Self-compensating Nm/cycle	W <sub>3</sub> Optimised Nm/cycle										
SCS33-25EU	310	500	45	90	23.2	138	83	25	60	68	3	0.51
SCS33-50EU	620	950	45	135	48.6	189	108	32	86	93	2	0.63

<sup>1</sup> The values are reduced by 20 % at max. side load angle.

**SCS45EU**

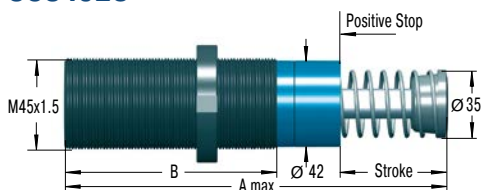

The calculation and selection of the most suitable damper should be carried out or be approved by ACE.

**Accessories**

**NM45**

Locking Ring

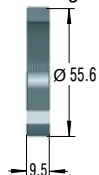

**QF45**

Square Flange

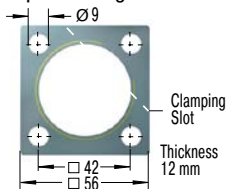

Torque max.: 27 Nm  
Clamping torque: > 200 Nm  
Install with 4 machine screws

**S45**

Side Foot Mounting Kit

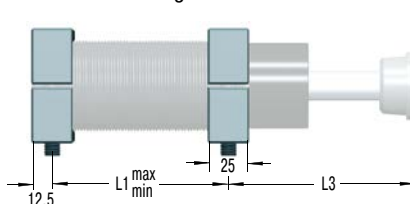

S45 = 2 flanges + 4 screws M8x50, DIN 912

Torque max.: 27 Nm

Clamping torque: 350 Nm

Because of the thread pitch the fixing holes for the second foot mount should only be drilled and tapped after the first foot mount has been fixed in position.

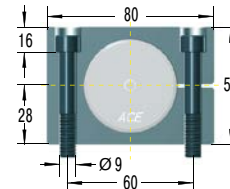

**Complete details required when ordering**

- Moving load: m (kg)
- Impact velocity range: v (m/s) max.
- Creep speed: vs (m/s)
- Motor power: P (kW)
- Stall torque factor: ST (normal, 2.5)
- (Alternatively: Propelling force F (N))
- Number of absorbers in parallel: n

or technical data according to formulae and calculations on page 265.

**Ordering Example**

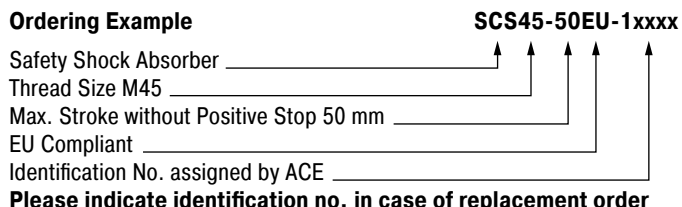

**Please indicate identification no. in case of replacement order**

**Performance and Dimensions**

TYPES	Max. Energy Capacity		Return Force min. N	Return Force max. N	Stroke mm	A max. mm	B mm	L1 min. mm	L1 max. mm	L3 mm	Side Load Angle max. °	Weight kg
	W <sub>3</sub> Self-compensating Nm/cycle	W <sub>3</sub> Optimised Nm/cycle										
SCS45-25EU	680	1,200	70	100	23.1	145	95	32	66	66	3	1.13
SCS45-50EU	1,360	2,350	70	145	48.5	195	120	40	92	91	2	1.36
SCS45-75EU	2,040	3,500	50	180	73.9	246	145	50	118	116	1	1.59

<sup>1</sup> The values are reduced by 20 % at max. side load angle.

**SCS64EU**

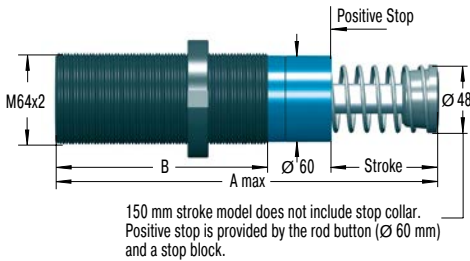

The calculation and selection of the most suitable damper should be carried out or be approved by ACE.

**Accessories**

**NM64**  
Locking Ring

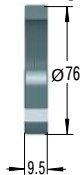

**QF64**  
Square Flange

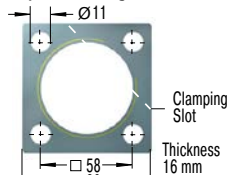

Torque max.: 50 Nm  
Clamping torque: > 210 Nm  
Install with 4 machine screws

**S64**  
Side Foot Mounting Kit

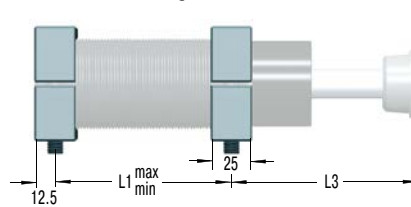

S64 = 2 flanges + 4 screws M10x80, DIN 912  
Torque max.: 50 Nm  
Clamping torque: 350 Nm  
Because of the thread pitch the fixing holes for the second foot mount should only be drilled and tapped after the first foot mount has been fixed in position.

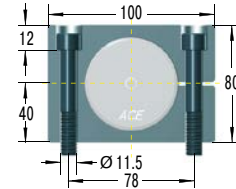

**Complete details required when ordering**

- Moving load: m (kg)
- Impact velocity range: v (m/s) max.
- Creep speed: vs (m/s)
- Motor power: P (kW)
- Stall torque factor: ST (normal, 2.5)  
(Alternatively: Propelling force F (N))
- Number of absorbers in parallel: n

or technical data according to formulae and calculations on page 265.

**Ordering Example**

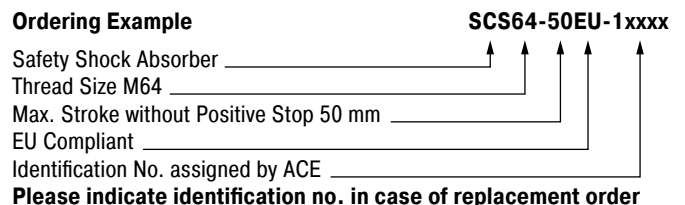

**Performance and Dimensions**

TYPES	Max. Energy Capacity		Return Force min. N	Return Force max. N	Stroke mm	A max. mm	B mm	L1 min. mm	L1 max. mm	L3 mm	Side Load Angle max. °	Weight kg
	W <sub>3</sub> Self-compensating Nm/cycle	W <sub>3</sub> Optimised Nm/cycle										
SCS64-50EU	3,400	6,000	90	155	48.6	225	140	50	112	100	3	2.90
SCS64-100EU	6,800	12,000	105	270	99.4	326	191	64	162	152	2	3.70
SCS64-150EU	10,200	18,000	75	365	150.0	450	241	80	212	226	1	5.10

<sup>1</sup> The values are reduced by 20 % at max. side load angle.



## SDH38 to SDH63

Low reaction forces with long strokes

**High Rack Damper, Optimized Characteristic**  
**Energy capacity 3,600 Nm/Cycle to 229,100 Nm/Cycle**  
**Stroke 100 mm to 800 mm**

Intelligent protective measure: The safety shock absorbers from the SDH38 to SDH63 series are also designed for emergency-stop applications. Strokes of up to 1,200 mm are possible with these maintenance-free and ready-to-install dampers. Low support forces result due to the large strokes.

The characteristic curve or damping characteristics of all safety shock absorbers from ACE is individually adjusted to the respective application, specific to the customer. The metering orifices for the respective application are specially calculated and produced. These tailor-made machine elements are the ideal protection because they are less expensive than industrial shock absorbers and are effective with up to 1,000 maximum full load emergency cycles possible.

Anyone who wants to reliably protect the end positions of rack operating equipment, conveyor and crane systems, heavy duty applications and test benches chooses these safety shock absorbers from ACE.

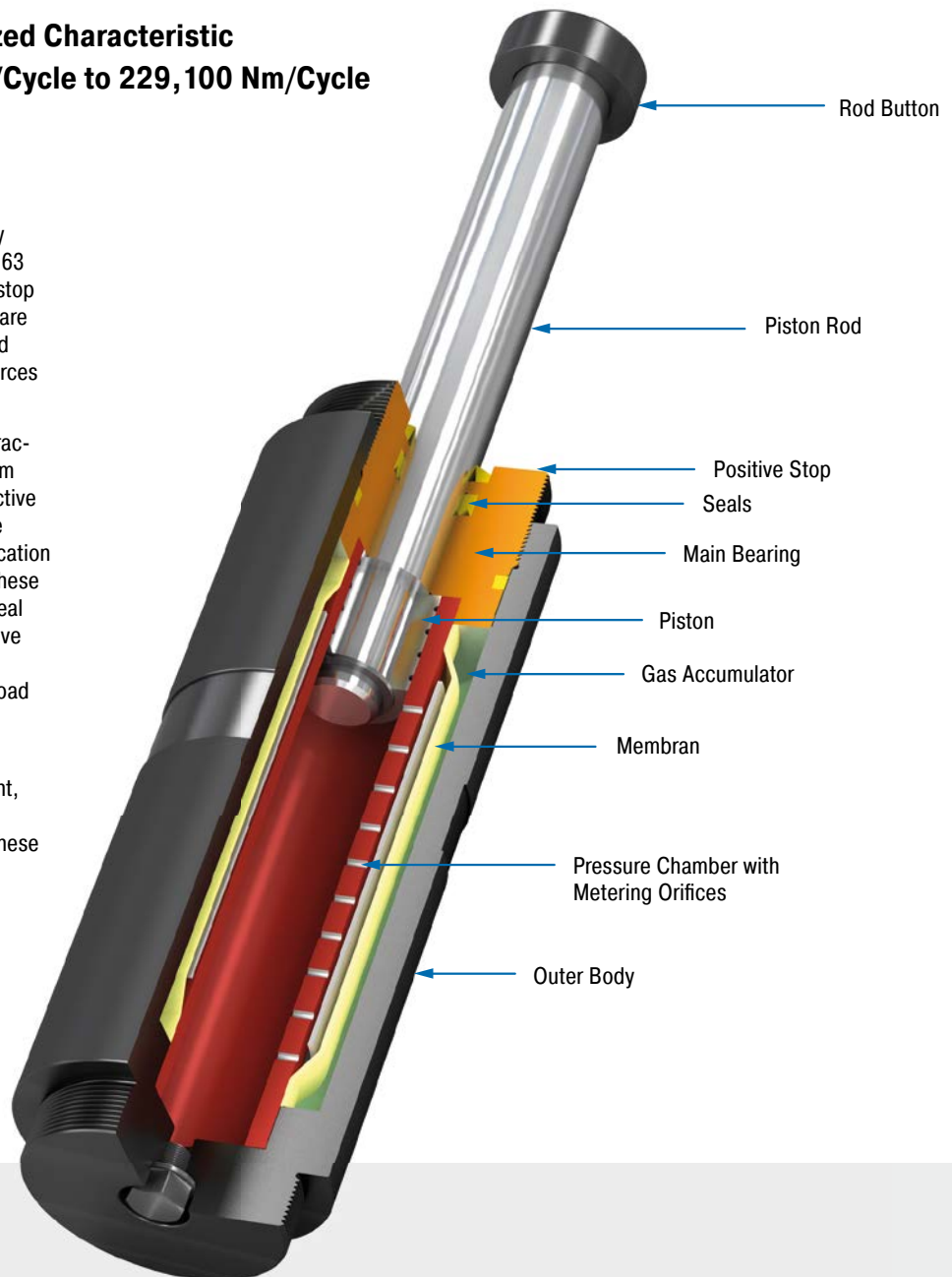

### Technical Data

**Energy capacity:** 3,600 Nm/Cycle to 229,100 Nm/Cycle

**Impact velocity range:** 0.5 m/s to 4.6 m/s. Other speeds on request.

**Reacting force:** At max. capacity rating = 51 kN to 210 kN

**Operating temperature range:** -20 °C to +60 °C. Other temperatures on request.

**Mounting:** In any position

**Positive stop:** Integrated

**Material:** Outer body: Painted steel; Piston rod: Hard chrome plated steel; Rod end button: Steel

**Damping medium:** HLP 46

**Filling pressure:** Approx. 5 bar. Rod return by integrated nitrogen accumulator.

**Application field:** Shelf storage systems, Test stations, Heavy load applications, Conveyor systems, Portal systems

**Note:** For creep speed applications, please consult ACE.

**On request:** Special oils, special flanges, additional corrosion protection etc. Integrated rod sensor for indicating the complete extension of the piston rod. Type normally closed or normally open, option PNP or NPN switch.

**SDH38EU-F Front Flange**

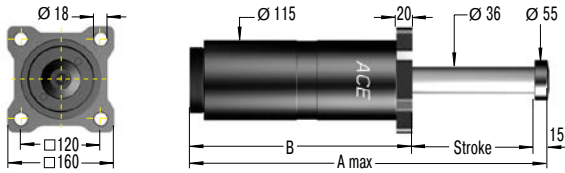

**SDH38EU-R Rear Flange**

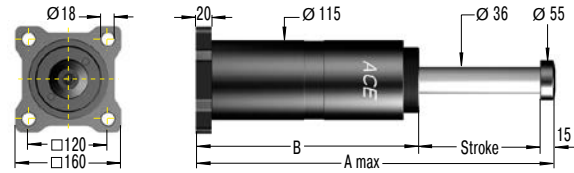

**SDH38EU-S Foot Mount**

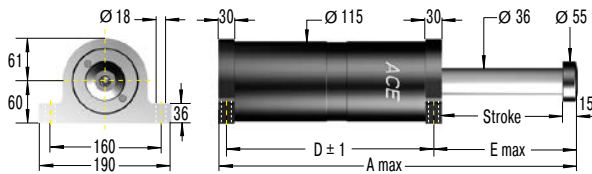

**Technical Data**

**Impact velocity range:** 0.9 m/s to 4.6 m/s

**Complete details required when ordering**

- Moving load: m (kg)
- Impact velocity range: v (m/s) max.
- Creep speed: vs (m/s)
- Motor power: P (kW)
- Stall torque factor: ST (normal, 2.5)
- (Alternatively: Propelling force F (N))
- Number of absorbers in parallel: n

or technical data according to formulae and calculations on page 265.

**The calculation and selection of the most suitable damper should be carried out or be approved by ACE.**

**Ordering Example**

**SDH38-400EU-F-XXXX**

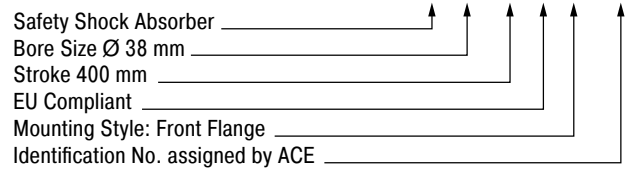

**Please indicate identification no. in case of replacement order**

**Performance and Dimensions**

TYPES	1 Energy capacity Nm/cycle	1 Reacting Force N	Return Force		Stroke mm	A max. mm	B mm	D mm	E max. mm	Mounting Style	
			min. N	max. N						F and R Weight kg	S Weight kg
SDH38-50EU	3,600	80,000	600	700	50	270	204	165	84	14.0	13.7
SDH38-100EU	7,300	80,000	600	700	100	370	254	215	134	15.5	15.7
SDH38-150EU	10,900	80,000	600	700	150	470	304	265	184	17.0	17.2
SDH38-200EU	14,500	80,000	600	700	200	585	369	330	234	20.0	19.7
SDH38-250EU	18,200	80,000	600	700	250	685	419	380	284	22.0	21.7
SDH38-300EU	21,800	80,000	600	700	300	800	484	445	334	24.0	23.7
SDH38-350EU	25,500	80,000	600	700	350	900	534	495	384	26.0	25.7
SDH38-400EU	29,100	80,000	600	700	400	1,015	599	560	434	28.0	28.2
SDH38-500EU	36,400	80,000	600	700	500	1,230	714	675	534	32.0	32.2
SDH38-600EU	43,600	80,000	600	700	600	1,445	829	790	634	36.0	36.2
SDH38-700EU	50,900	80,000	600	700	700	1,660	944	905	734	40.0	40.2
SDH38-800EU	58,200	80,000	600	700	800	1,875	1,059	1,020	834	44.0	44.2

1 The values apply to mounting style Front Flange and Foot Mounting. For mounting style Rear Flange, please consult ACE.  
In case of an existing side load angle, please consult ACE.



**SDH50EU-F Front Flange**

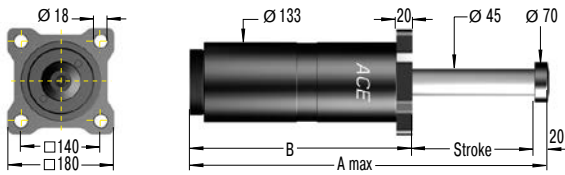

**SDH50EU-R Rear Flange**

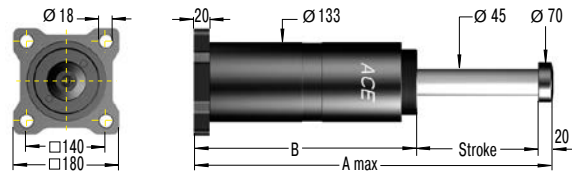

**SDH50EU-S Foot Mount**

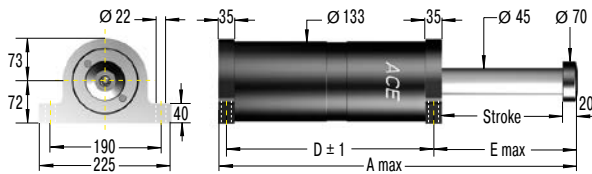

**Technical Data**

Impact velocity range: 0.6 m/s to 4.6 m/s

**Complete details required when ordering**

- Moving load: m (kg)
- Impact velocity range: v (m/s) max.
- Creep speed: vs (m/s)
- Motor power: P (kW)
- Stall torque factor: ST (normal, 2.5)
- (Alternatively: Propelling force F (N))
- Number of absorbers in parallel: n

or technical data according to formulae and calculations on page 265.

The calculation and selection of the most suitable damper should be carried out or be approved by ACE.

**Ordering Example**

**SDH50-400EU-F-XXXXX**

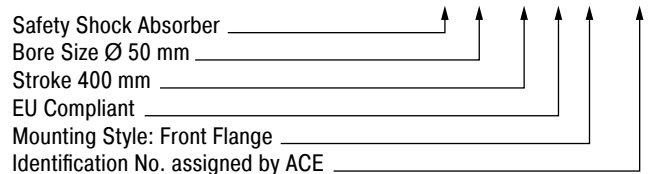

**Please indicate identification no. in case of replacement order**

**Performance and Dimensions**

TYPES	1 Energy capacity Nm/cycle	1 Reacting Force N	Return Force		Stroke mm	A max. mm	B mm	D mm	E max. mm	Mounting Style	
			min. N	max. N						F and R Weight kg	S Weight kg
SDH50-100EU	14,500	160,000	1,000	1,200	100	416	297	258	139	23.5	25.0
SDH50-150EU	21,800	160,000	1,000	1,200	150	516	347	308	189	26.0	27.5
SDH50-200EU	29,100	160,000	1,000	1,200	200	616	397	358	239	28.5	30.0
SDH50-250EU	36,400	160,000	1,000	1,200	250	731	462	423	289	32.0	33.5
SDH50-300EU	43,600	160,000	1,000	1,200	300	831	512	473	339	34.5	36.0
SDH50-350EU	50,900	160,000	1,000	1,200	350	931	562	523	389	37.0	38.5
SDH50-400EU	58,200	160,000	1,000	1,200	400	1,046	627	588	439	40.0	41.5
SDH50-500EU	72,700	160,000	1,000	1,200	500	1,261	742	703	539	46.0	47.5
SDH50-600EU	87,300	160,000	1,000	1,200	600	1,476	857	818	639	52.0	53.5
SDH50-700EU	101,800	160,000	1,000	1,200	700	1,691	972	933	739	58.0	59.5
SDH50-800EU	116,400	160,000	1,000	1,200	800	1,906	1,087	1,048	839	64.0	65.5
SDH50-1000EU	145,500	160,000	1,000	1,200	1,000	2,336	1,317	1,278	1,039	75.0	76.5

1 The values apply to mounting style Front Flange and Foot Mounting. For mounting style Rear Flange, please consult ACE. In case of an existing side load angle, please consult ACE.

### SDH63EU-F Front Flange

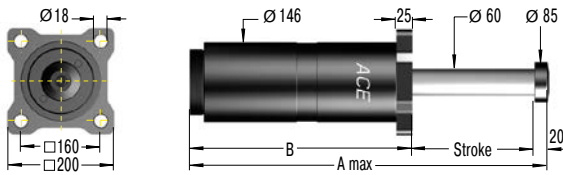

### SDH63EU-R Rear Flange

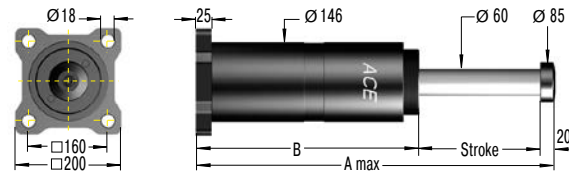

### SDH63EU-S Foot Mount

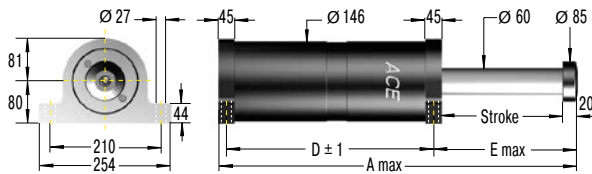

## Technical Data

Impact velocity range: 0.5 m/s to 4.6 m/s

### Complete details required when ordering

- Moving load: m (kg)
- Impact velocity range: v (m/s) max.
- Creep speed: vs (m/s)
- Motor power: P (kW)
- Stall torque factor: ST (normal, 2.5)
- (Alternatively: Propelling force F (N))
- Number of absorbers in parallel: n

or technical data according to formulae and calculations on page 265.

The calculation and selection of the most suitable damper should be carried out or be approved by ACE.

### Ordering Example

**SDH63-400EU-F-XXXXX**  
 Safety Shock Absorber \_\_\_\_\_  
 Bore Size Ø 63 mm \_\_\_\_\_  
 Stroke 400 mm \_\_\_\_\_  
 EU Compliant \_\_\_\_\_  
 Mounting Style: Front Flange \_\_\_\_\_  
 Identification No. assigned by ACE \_\_\_\_\_

**Please indicate identification no. in case of replacement order**

## Performance and Dimensions

TYPES	1 Energy capacity Nm/cycle	1 Reacting Force N	Return Force		Stroke mm	A max. mm	B mm	D mm	E max. mm	Mounting Style	
			min. N	max. N						F and R Weight kg	S Weight kg
SDH63-100EU	19,100	210,000	1,500	2,500	100	420	301	252	144	32	35
SDH63-150EU	28,600	210,000	1,500	2,500	150	520	351	302	194	35	38
SDH63-200EU	38,200	210,000	1,500	2,500	200	620	401	352	244	39	42
SDH63-250EU	47,700	210,000	1,500	2,500	250	720	451	402	294	43	46
SDH63-300EU	57,300	210,000	1,500	2,500	300	850	531	482	344	48	51
SDH63-350EU	66,800	210,000	1,500	2,500	350	950	581	532	394	52	55
SDH63-400EU	76,400	210,000	1,500	2,500	400	1,080	661	612	444	60	63
SDH63-500EU	95,500	210,000	1,500	2,500	500	1,280	761	712	544	68	71
SDH63-600EU	114,500	210,000	1,500	2,500	600	1,510	891	842	644	78	81
SDH63-700EU	133,600	210,000	1,500	2,500	700	1,740	1,021	972	744	88	91
SDH63-800EU	152,700	210,000	1,500	2,500	800	1,970	1,151	1,102	844	98	101
SDH63-1000EU	190,900	210,000	1,500	2,500	1,000	2,430	1,411	1,362	1,044	118	121
SDH63-1200EU	229,100	210,000	1,500	2,500	1,200	2,890	1,671	1,622	1,244	138	141

<sup>1</sup> The values apply to mounting style Front Flange and Foot Mounting. For mounting style Rear Flange, please consult ACE.  
In case of an existing side load angle, please consult ACE.

## SDP63 to SDP160

### High return forces with gas pressure accumulator

**Crane Installations, Optimized Characteristic**  
**Energy capacity 9,100 Nm/Cycle to 582,000 Nm/Cycle**  
**Stroke 50 mm to 1,200 mm**

**Reliability:** The emergency stop from the large scale SDP63 to SDP160 series have internal system seals. Even dirt or damages to the piston rod do not lead to a leakage or failure. Compressed gas accumulators allow return forces of up to 100 kN, which can make applications in multiple bridge crane systems safer, for example. The absorber body and the robust, large-sized piston rod bearing are also designed for heavy duty operations

Just like all ACE safety shock absorbers, the characteristic curve or damping characteristics of each individual absorber is individually adjusted to the respective application.

Whether its crane systems or machines in heavy duty applications e.g. in the metal industry or in mining, these powerful safety shock absorbers reliably protect construction designs against expensive failure.

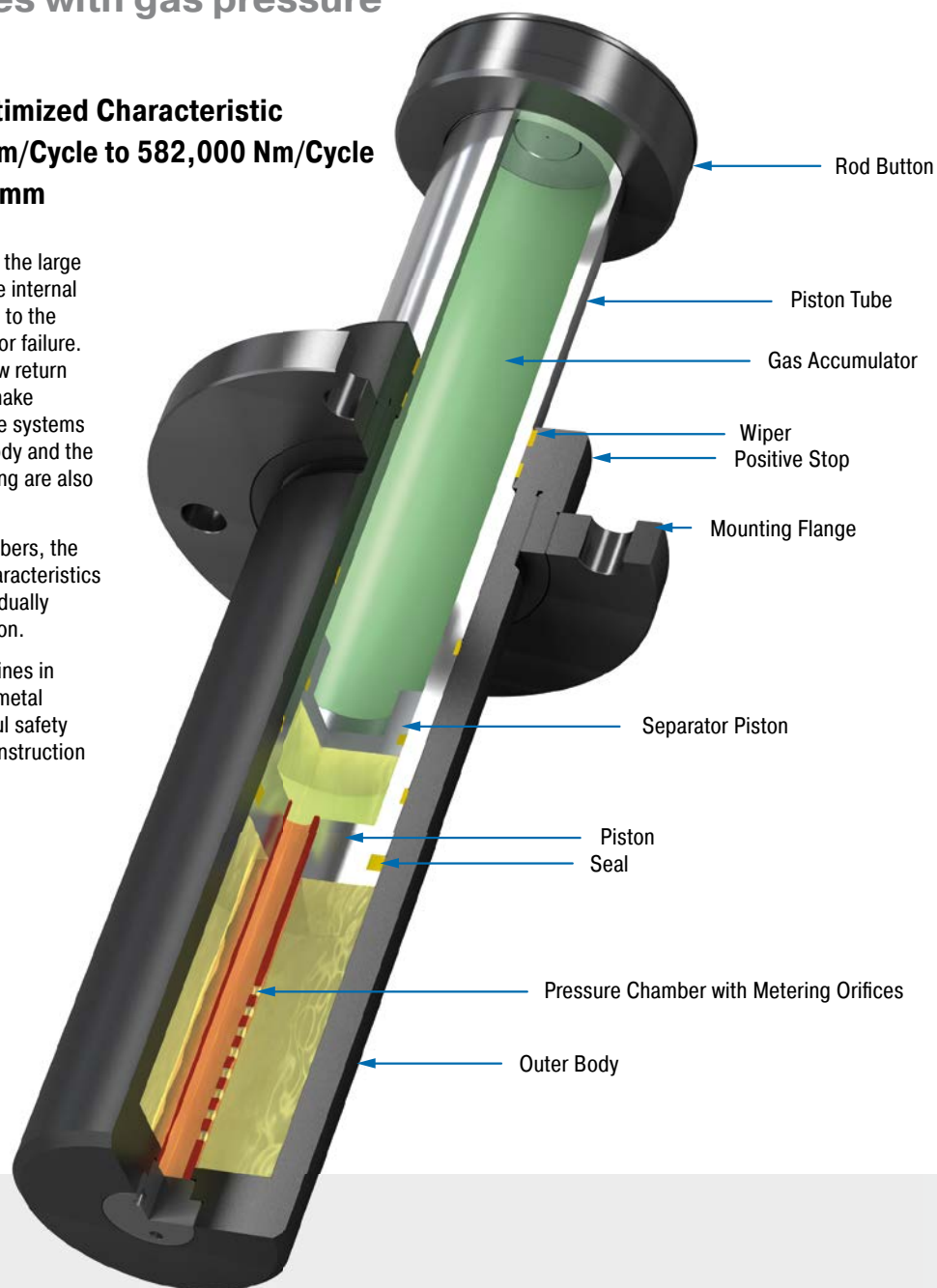

### Technical Data

**Energy capacity:** 9,100 Nm/Cycle to 582,000 Nm/Cycle

**Impact velocity range:** 0.5 m/s to 4.6 m/s. Other speeds on request.

**Reacting force:** At max. capacity rating = 110 kN to 1.000 kN

**Operating temperature range:** -20 °C to +60 °C. Other temperatures on request.

**Mounting:** In any position

**Positive stop:** Integrated

**Material:** Outer body: Painted steel; Rod end button: Steel; Piston tube: Hard chrome plated steel

**Damping medium:** HLP 46

**Filling pressure:** Approx. 5 bar. Rod return by integrated nitrogen accumulator.

**Application field:** Shelf storage systems, Heavy load applications

**Note:** The shock absorber can be pushed through its stroke. In creep speed conditions the shock absorber provides minimal resistance and there is no braking effect.

**On request:** Special oils, special flanges, additional corrosion protection etc.

**SDP63EU-F Front Flange**

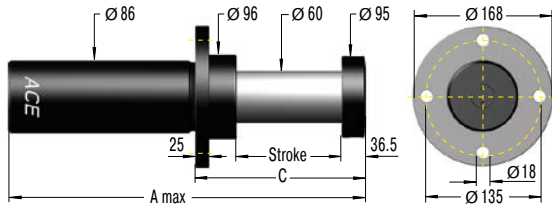

**SDP63EU-R Rear Flange**

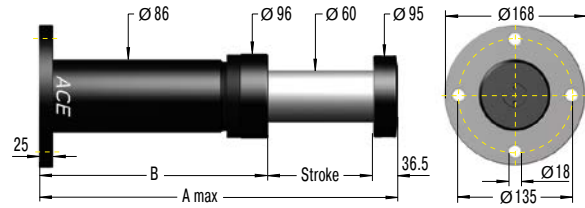

**Technical Data**

**Impact velocity range:** 0.5 m/s to 4.6 m/s. Other speeds on request.

**The calculation and selection of the most suitable damper should be carried out or be approved by ACE.**

**Complete details required when ordering**

- Moving load: m (kg)
- Impact velocity range: v (m/s) max.
- Creep speed: vs (m/s)
- Motor power: P (kW)
- Stall torque factor: ST (normal, 2.5)
- (Alternatively: Propelling force F (N))
- Number of absorbers in parallel: n

or technical data according to formulae and calculations on page 265.

**Ordering Example**

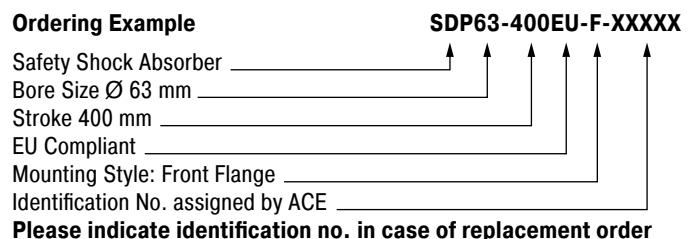

**Please indicate identification no. in case of replacement order**

**Performance and Dimensions**

TYPES	Energy capacity Nm/cycle	Reacting Force N	Return Force min. N	Return Force max. N	Stroke mm	A max. mm	B mm	C mm	Weight kg
SDP63-50EU	9,100	200,000	1,500	8,000	50	280	193.5	145	11
SDP63-75EU	13,600	200,000	1,500	10,000	75	360	248.5	170	12.5
SDP63-100EU	18,200	200,000	1,500	11,000	100	425	288.5	195	14
SDP63-150EU	27,300	200,000	1,500	15,000	150	560	373.5	245	17
SDP63-200EU	36,400	200,000	1,500	17,000	200	700	463.5	295	19
SDP63-250EU	43,200	190,000	1,500	18,000	250	840	553.5	345	21
SDP63-300EU	49,100	180,000	1,500	20,000	300	980	643.5	395	24
SDP63-400EU	54,500	150,000	1,500	20,000	400	1,265	828.5	495	29
SDP63-500EU	59,100	130,000	1,500	20,000	500	1,555	1,018.5	595	34
SDP63-600EU	60,000	110,000	1,500	20,000	600	1,840	1,203.5	695	39

In case of an existing side load angle, please consult ACE.

**SDP80EU-F Front Flange**

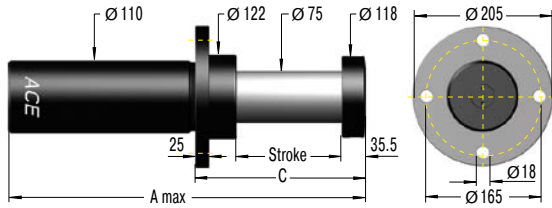

**SDP80EU-R Rear Flange**

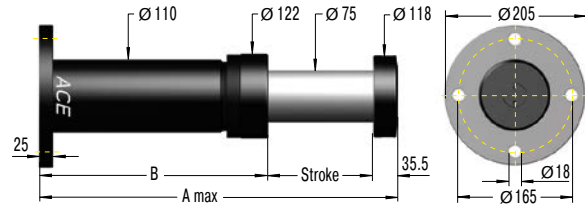

**Technical Data**

**Impact velocity range:** 0.5 m/s to 4.6 m/s. Other speeds on request.

**The calculation and selection of the most suitable damper should be carried out or be approved by ACE.**

**Complete details required when ordering**

- Moving load: m (kg)
- Impact velocity range: v (m/s) max.
- Creep speed: vs (m/s)
- Motor power: P (kW)
- Stall torque factor: ST (normal, 2.5)
- (Alternatively: Propelling force F (N))
- Number of absorbers in parallel: n

or technical data according to formulae and calculations on page 265.

**Ordering Example**

**SDP80-200EU-F-XXXXX**

Safety Shock Absorber \_\_\_\_\_ ↑

Bore Size Ø 80 mm \_\_\_\_\_ ↑

Stroke 200 mm \_\_\_\_\_ ↑

EU Compliant \_\_\_\_\_ ↑

Mounting Style: Front Flange \_\_\_\_\_ ↑

Identification No. assigned by ACE \_\_\_\_\_ ↑

**Please indicate identification no. in case of replacement order**

**Performance and Dimensions**

TYPES	Energy capacity Nm/cycle	Reacting Force N	Return Force min. N	Return Force max. N	Stroke mm	A max. mm	B mm	C mm	Weight kg
SDP80-50EU	11,800	260,000	2,500	16,000	50	285	199.5	155	19
SDP80-100EU	23,600	260,000	2,500	16,000	100	440	304.5	205	23
SDP80-150EU	35,500	260,000	2,500	20,000	150	580	394.5	255	27
SDP80-200EU	47,300	260,000	2,500	20,000	200	730	494.5	305	32
SDP80-250EU	56,800	250,000	2,500	25,000	250	865	579.5	355	35
SDP80-300EU	65,500	240,000	2,500	25,000	300	1,010	674.5	405	39
SDP80-400EU	80,000	220,000	2,500	30,000	400	1,285	849.5	505	47
SDP80-500EU	90,900	200,000	2,500	30,000	500	1,575	1,039.5	605	55
SDP80-600EU	98,200	180,000	2,500	30,000	600	1,865	1,229.5	705	64
SDP80-800EU	101,800	140,000	2,500	30,000	800	2,450	1,614.5	905	80

In case of an existing side load angle, please consult ACE.

**SDP100EU-F Front Flange**

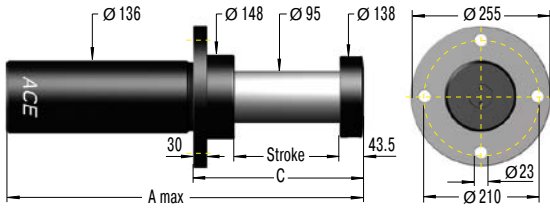

**SDP100EU-R Rear Flange**

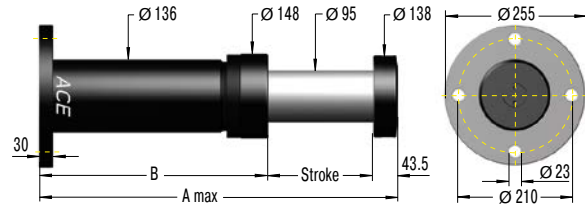

**Technical Data**

**Impact velocity range:** 0.5 m/s to 4.6 m/s. Other speeds on request.

**The calculation and selection of the most suitable damper should be carried out or be approved by ACE.**

**Complete details required when ordering**

- Moving load: m (kg)
- Impact velocity range: v (m/s) max.
- Creep speed: vs (m/s)
- Motor power: P (kW)
- Stall torque factor: ST (normal, 2.5)
- (Alternatively: Propelling force F (N))
- Number of absorbers in parallel: n

or technical data according to formulae and calculations on page 265.

**Ordering Example**



**Please indicate identification no. in case of replacement order**

**Performance and Dimensions**

TYPES	Energy capacity Nm/cycle	Reacting Force N	Return Force min. N	Return Force max. N	Stroke mm	A max. mm	B mm	C mm	Weight kg
SDP100-100EU	47,000	520,000	3,900	38,000	100	460	316.5	230	38
SDP100-200EU	95,000	520,000	3,900	38,000	200	750	506.5	330	53
SDP100-250EU	114,000	520,000	3,900	40,000	250	890	596.5	380	59
SDP100-300EU	131,000	500,000	3,900	40,000	300	1,035	691.5	430	66
SDP100-400EU	160,000	480,000	3,900	40,000	400	1,325	881.5	530	81
SDP100-500EU	182,000	440,000	3,900	40,000	500	1,610	1,066.5	630	93
SDP100-600EU	196,000	360,000	3,900	46,000	600	1,880	1,236.5	730	103
SDP100-800EU	218,000	300,000	3,900	46,000	800	2,450	1,606.5	930	125
SDP100-1000EU	236,000	260,000	3,900	46,000	1,000	3,020	1,976.5	1,130	160

In case of an existing side load angle, please consult ACE.



**SDP120EU-F Front Flange**

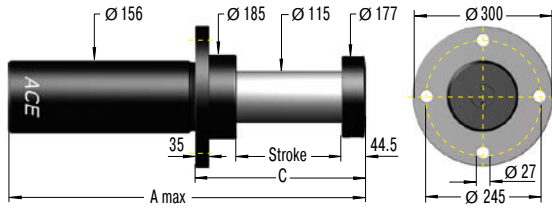

**SDP120EU-R Rear Flange**

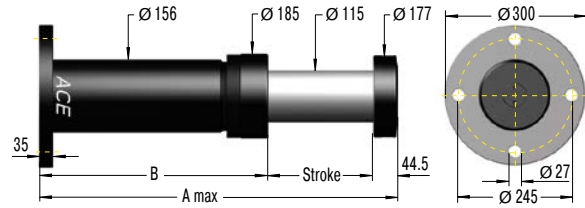

**Technical Data**

**Impact velocity range:** 0.5 m/s to 4.6 m/s. Other speeds on request.

**The calculation and selection of the most suitable damper should be carried out or be approved by ACE.**

**Complete details required when ordering**

- Moving load: m (kg)
- Impact velocity range: v (m/s) max.
- Creep speed: vs (m/s)
- Motor power: P (kW)
- Stall torque factor: ST (normal, 2.5)
- (Alternatively: Propelling force F (N))
- Number of absorbers in parallel: n

or technical data according to formulae and calculations on page 265.

**Ordering Example**

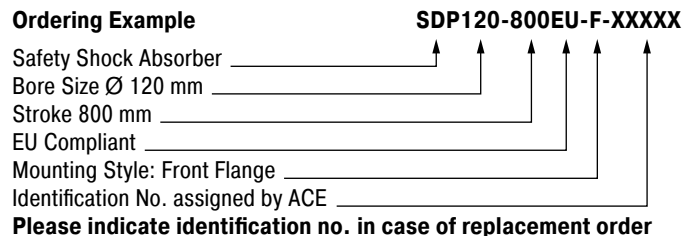

**Please indicate identification no. in case of replacement order**

**Performance and Dimensions**

TYPES	Energy capacity Nm/cycle	Reacting Force N	Return Force min. N	Return Force max. N	Stroke mm	A max. mm	B mm	C mm	Weight kg
SDP120-100EU	64,000	700,000	5,600	35,000	100	460	315.5	249	58
SDP120-200EU	127,000	700,000	5,600	70,000	200	750	505.5	355	72
SDP120-400EU	236,000	650,000	5,600	75,000	400	1,325	880.5	555	99
SDP120-600EU	300,000	550,000	5,600	75,000	600	1,880	1,235.5	755	125
SDP120-800EU	327,000	450,000	5,600	75,000	800	2,450	1,605.5	955	160
SDP120-1000EU	364,000	400,000	5,600	75,000	1,000	3,020	1,975.5	1,155	192
SDP120-1200EU	436,000	400,000	5,600	75,000	1,200	3,590	2,345.5	1,355	225

In case of an existing side load angle, please consult ACE.

**SDP160EU-F Front Flange**

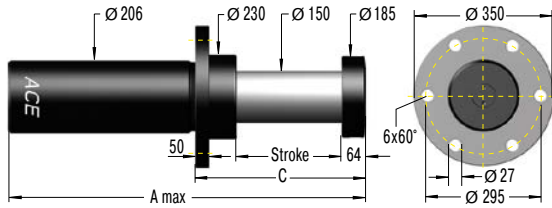

**SDP160EU-R Rear Flange**

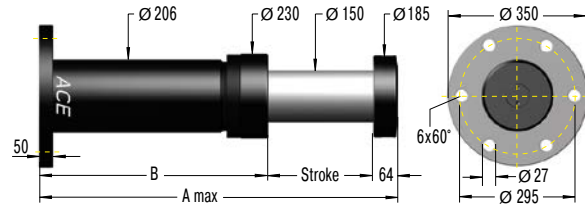

**Technical Data**

**Impact velocity range:** 0.5 m/s to 4.6 m/s. Other speeds on request.

**The calculation and selection of the most suitable damper should be carried out or be approved by ACE.**

**Complete details required when ordering**

- Moving load: m (kg)
- Impact velocity range: v (m/s) max.
- Creep speed: vs (m/s)
- Motor power: P (kW)
- Stall torque factor: ST (normal, 2.5)
- (Alternatively: Propelling force F (N))
- Number of absorbers in parallel: n

**Ordering Example**

**SDP160-400EU-F-XXXXX**

Safety Shock Absorber \_\_\_\_\_

Bore Size Ø 160 mm \_\_\_\_\_

Stroke 400 mm \_\_\_\_\_

EU Compliant \_\_\_\_\_

Mounting Style: Front Flange \_\_\_\_\_

Identification No. assigned by ACE \_\_\_\_\_

**Please indicate identification no. in case of replacement order**

or technical data according to formulae and calculations on page 265.

**Performance and Dimensions**

TYPES	Energy capacity Nm/cycle	Reacting Force N	Return Force min. N	Return Force max. N	Stroke mm	A max. mm	B mm	C mm	Weight kg
SDP160-200EU	182,000	1,000,000	1,000	80,000	200	860	596	440	105
SDP160-400EU	345,000	950,000	1,000	80,000	400	1,485	1,021	640	165
SDP160-500EU	409,000	900,000	1,000	90,000	500	1,765	1,201	740	195
SDP160-600EU	469,000	860,000	1,000	95,000	600	2,065	1,401	840	230
SDP160-800EU	545,000	750,000	1,000	100,000	800	2,660	1,796	1,040	290
SDP160-1000EU	545,000	600,000	1,000	110,000	1,000	3,225	2,161	1,240	350
SDP160-1200EU	545,000	500,000	1,000	110,000	1,200	3,815	2,551	1,440	410
SDP160-1600EU	582,000	400,000	1,000	110,000	1,600	4,995	3,331	1,840	530

In case of an existing side load angle, please consult ACE.

### Permitted Use

ACE safety shock absorbers are machine elements to brake moving masses in a defined end position in emergency stop situations for axial forces. The safety shock absorbers are not designed for regular operational usage.

### Calculation of safety shock absorbers

The calculation of safety shock absorbers should generally be performed or checked by ACE.

### Deceleration Properties

The orifice sizing and drill pattern in the pressure chamber are individually designed for each safety shock absorber. The respective absorption characteristic is optimised corresponding to the maximum mass that occurs in the emergency stop and the impact speed. Correspondingly, each safety shock absorber is given an individual identification number.

### Model Code

For types SCS33 to 64, the individual five-digit identification numbers can be taken from the last digits of the shock absorber model code shown on the label. Example: SCS33-50EU-1XXXX. For type series SDH38 to SDH63 and SDP63 to SDP160, the identification number is a five digit number. Example: SDH38-400EU-F-XXXXX. In addition to the model code, the label also shows the authorised maximum impact velocity and maximum authorised impact mass for the unit.

### Mounting

To mount the shock absorber, we recommend the use of original ACE mounting accessories shown in catalogue.

The mounting of each shock absorber must be exactly positioned so that the reaction force (Q) can be adequately transmitted into the mounting structure.

ACE recommends installation via the front flange -F mounting style that ensures the maximum protection against buckling. The damper must be mounted so that the moving loads are decelerated with the least possible side loading to the piston rod. The maximum permissible side load angles are detailed in our current catalogue.

The entire stroke length must be used for deceleration because only using part of the stroke can lead to overstressing and damage to the unit.

### Mounting style front flange

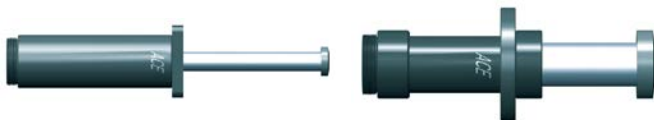

Safety Shock Absorber SDH

Safety Shock Absorber SDP

### Environmental Requirements

The permissible **temperature range** for each shock absorber type can be found in our current catalogue.

**Caution:** Usage outside the specified temperature range can lead to premature breakdown and damage of the shock absorbers which can then result in severe system damage or machine failures.

Trouble free operation outdoors or in damp environments is only warranted if the dampers are coated with a specific corrosion protection finish.

### Initial Start-Up Checks

First impacts on the shock absorber should only be tried after correctly mounting and with reduced impact speeds and – if possible – with reduced load. Differences between calculated and actual operating data can then be detected early on, and damage to your system can be avoided. If the shock absorbers were selected on calculated data that does not correspond to the maximum possible loading (i.e. selection based on drive power being switched off or at reduced impact speed) then these restricted impact conditions must not be exceeded during initial testing or subsequent use of the system. Otherwise you risk damaging the shock absorbers and/or your machine by overstressing materials. After the initial trial check that the piston rod fully extends again and that there are no signs of oil leakage. Also check that the mounting hardware is still securely tightened. You need to satisfy yourself that no damage has occurred to the piston rod, the body, or the mounting hardware.

### Fixed Mechanical Stop

Safety shock absorbers do not need an external stop as a stroke limiter. The stroke of the safety absorber is limited by the stop of the impact head on the shock absorber. For types SCS33 to SCS64, the fixed stop point is achieved with the integrated stop collar.

### What Needs to be Checked after a Full Load Impact?

Safety shock absorbers that were originally checked only at reduced speed or load need to be checked again after a full load impact (i.e. emergency use) has occurred. Check that the piston rod fully extends to its full out position, that there are no signs of oil leakage and that the mounting hardware is still securely fixed. You need to satisfy yourself that no damage has occurred to the piston rod, the body, or the mounting hardware. If no damage has occurred, the safety shock absorber can be put back into normal operation (see **initial start-up**).

### Maintenance

Safety shock absorbers are sealed systems and do not need special maintenance. Safety shock absorbers that are not used regularly (i.e. that are intended for emergency stop systems) should be checked within the normal time frame for safety checks, but **at least once a year**. At this time special attention must be paid to checking that the piston rod resets to its fully extended position, that there is no oil leakage and that the mounting brackets are still secure and undamaged. The piston rod must not show any signs of damage. Safety shock absorbers that are **in use regularly** should be checked **every three months**.

### Repair Notice

If any damage to the shock absorber is detected or if there are any doubts as to the proper functioning of the unit please send the unit for service to ACE. Alternatively contact your local ACE office for further advice.

Detailed information on the above listed points can be taken from the corresponding operating and assembly instructions.

## Calculation Bases for the Design of Safety Shock Absorbers

More formulae on page 10 to 13

ACE shock absorbers provide linear deceleration and are therefore superior to other kinds of damping element. It is easy to calculate around 90 % of applications knowing only the following four parameters:

1. Mass to be decelerated (weight) **m** [kg]
2. Impact velocity at shock absorber **v<sub>D</sub>** [m/s]
3. Propelling force **F** [N]
4. Number of absorbers in parallel **n**

### Key to symbols used



$W_1$	Kinetic energy per cycle	Nm	${}^2v_D$	Impact velocity at shock absorber	m/s
$W_2$	Propelling force energy per cycle	Nm	F	Propelling force	N
$W_3$	Total energy per cycle ( $W_1 + W_2$ )	Nm	c	Cycles per hour	1/hr
${}^1W_4$	Total energy per hour ( $W_3 \cdot x$ )	Nm/hr	s	Shock absorber stroke	m
me	Effective weight	kg	Q	Reaction force	N
m	Mass to be decelerated	kg	t	Deceleration time	s
n	Number of shock absorbers (in parallel)		a	Deceleration	m/s <sup>2</sup>
${}^2v$	Velocity at impact	m/s			

<sup>1</sup> All mentioned values of W4 in the capacity charts are only valid for room temperature. There are reduced values at higher temperature ranges.

<sup>2</sup> v or v<sub>D</sub> is the final impact velocity of the mass. With accelerating motion the final impact velocity can be 1.5 to 2 times higher than the average. Please take this into account when calculating kinetic energy.

In all the following examples the choice of shock absorbers made from the capacity chart is based upon the values of ( $W_3$ ), ( $W_4$ ), (me) and the desired shock absorber stroke (s).

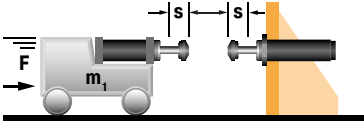
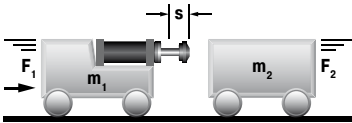
**Note:** When using several shock absorbers in parallel, the values ( $W_3$ ), ( $W_4$ ) and (me) are divided according to the number of units used.

Application	Formulae	Example																		
<b>19 Wagon against 2 shock absorbers</b> 	$W_1 = m \cdot v^2 \cdot 0.25$ $W_2 = F \cdot s$ $W_3 = W_1 + W_2$ $v_D = v \cdot 0.5$	<table border="0"> <tr> <td>m = 5000 kg</td> <td><math>W_1 = 5000 \cdot 2^2 \cdot 0.25</math></td> <td>= 5000 Nm</td> </tr> <tr> <td>v = 2 m/s</td> <td><math>W_2 = 3500 \cdot 0.10</math></td> <td>= 350 Nm</td> </tr> <tr> <td>F = 3500 N</td> <td><math>W_3 = 5000 + 350</math></td> <td>= 5350 Nm</td> </tr> <tr> <td>s = 0.10 m (chosen)</td> <td><math>v_D = 2 \cdot 0.5</math></td> <td>= 1 m/s</td> </tr> </table> <p>Chosen from capacity chart: Model SDH38-100EU self-compensating</p>	m = 5000 kg	$W_1 = 5000 \cdot 2^2 \cdot 0.25$	= 5000 Nm	v = 2 m/s	$W_2 = 3500 \cdot 0.10$	= 350 Nm	F = 3500 N	$W_3 = 5000 + 350$	= 5350 Nm	s = 0.10 m (chosen)	$v_D = 2 \cdot 0.5$	= 1 m/s						
m = 5000 kg	$W_1 = 5000 \cdot 2^2 \cdot 0.25$	= 5000 Nm																		
v = 2 m/s	$W_2 = 3500 \cdot 0.10$	= 350 Nm																		
F = 3500 N	$W_3 = 5000 + 350$	= 5350 Nm																		
s = 0.10 m (chosen)	$v_D = 2 \cdot 0.5$	= 1 m/s																		
<b>20 Wagon against wagon</b> 	$W_1 = \frac{m_1 \cdot m_2}{(m_1 + m_2)} \cdot (v_1 + v_2)^2 \cdot 0.5$ $W_2 = F \cdot s$ $W_3 = W_1 + W_2$ $v_D = v_1 + v_2$	<table border="0"> <tr> <td>m = 7000 kg</td> <td><math>W_1 = \frac{7000 \cdot 10000}{(7000 + 10000)} \cdot 1.7^2 \cdot 0.5</math></td> <td>= 5950 Nm</td> </tr> <tr> <td>v<sub>1</sub> = 1.2 m/s</td> <td><math>W_2 = 5000 \cdot 0.10</math></td> <td>= 500 Nm</td> </tr> <tr> <td>m<sub>2</sub> = 10000 kg</td> <td><math>W_3 = 5950 + 500</math></td> <td>= 6450 Nm</td> </tr> <tr> <td>v<sub>2</sub> = 0.5 m/s</td> <td><math>v_D = 1.2 + 0.5</math></td> <td>= 1.7 m/s</td> </tr> <tr> <td>F = 5000 N</td> <td></td> <td></td> </tr> <tr> <td>s = 0.10 m (chosen)</td> <td></td> <td></td> </tr> </table> <p>Chosen from capacity chart: Model SDH50-100EU self-compensating</p>	m = 7000 kg	$W_1 = \frac{7000 \cdot 10000}{(7000 + 10000)} \cdot 1.7^2 \cdot 0.5$	= 5950 Nm	v <sub>1</sub> = 1.2 m/s	$W_2 = 5000 \cdot 0.10$	= 500 Nm	m <sub>2</sub> = 10000 kg	$W_3 = 5950 + 500$	= 6450 Nm	v <sub>2</sub> = 0.5 m/s	$v_D = 1.2 + 0.5$	= 1.7 m/s	F = 5000 N			s = 0.10 m (chosen)		
m = 7000 kg	$W_1 = \frac{7000 \cdot 10000}{(7000 + 10000)} \cdot 1.7^2 \cdot 0.5$	= 5950 Nm																		
v <sub>1</sub> = 1.2 m/s	$W_2 = 5000 \cdot 0.10$	= 500 Nm																		
m <sub>2</sub> = 10000 kg	$W_3 = 5950 + 500$	= 6450 Nm																		
v <sub>2</sub> = 0.5 m/s	$v_D = 1.2 + 0.5$	= 1.7 m/s																		
F = 5000 N																				
s = 0.10 m (chosen)																				
<b>21 Wagon against wagon 2 shock absorbers</b> 	$W_1 = \frac{m_1 \cdot m_2}{(m_1 + m_2)} \cdot (v_1 + v_2)^2 \cdot 0.25$ $W_2 = F \cdot s$ $W_3 = W_1 + W_2$ $v_D = \frac{v_1 + v_2}{2}$	<table border="0"> <tr> <td>m = 7000 kg</td> <td><math>W_1 = \frac{7000 \cdot 10000}{(7000 + 10000)} \cdot 1.7^2 \cdot 0.25</math></td> <td>= 2975 Nm</td> </tr> <tr> <td>v<sub>1</sub> = 1.2 m/s</td> <td><math>W_2 = 5000 \cdot 0.10</math></td> <td>= 500 Nm</td> </tr> <tr> <td>m<sub>2</sub> = 10000 kg</td> <td><math>W_3 = 2975 + 510</math></td> <td>= 3475 Nm</td> </tr> <tr> <td>v<sub>2</sub> = 0.5 m/s</td> <td><math>v_D = (1.2 + 0.5) : 2</math></td> <td>= 0.85 m/s</td> </tr> <tr> <td>F = 5000 N</td> <td></td> <td></td> </tr> <tr> <td>s = 0.10 m (chosen)</td> <td></td> <td></td> </tr> </table> <p>Chosen from capacity chart: Model SDH38-100EU self-compensating</p>	m = 7000 kg	$W_1 = \frac{7000 \cdot 10000}{(7000 + 10000)} \cdot 1.7^2 \cdot 0.25$	= 2975 Nm	v <sub>1</sub> = 1.2 m/s	$W_2 = 5000 \cdot 0.10$	= 500 Nm	m <sub>2</sub> = 10000 kg	$W_3 = 2975 + 510$	= 3475 Nm	v <sub>2</sub> = 0.5 m/s	$v_D = (1.2 + 0.5) : 2$	= 0.85 m/s	F = 5000 N			s = 0.10 m (chosen)		
m = 7000 kg	$W_1 = \frac{7000 \cdot 10000}{(7000 + 10000)} \cdot 1.7^2 \cdot 0.25$	= 2975 Nm																		
v <sub>1</sub> = 1.2 m/s	$W_2 = 5000 \cdot 0.10$	= 500 Nm																		
m <sub>2</sub> = 10000 kg	$W_3 = 2975 + 510$	= 3475 Nm																		
v <sub>2</sub> = 0.5 m/s	$v_D = (1.2 + 0.5) : 2$	= 0.85 m/s																		
F = 5000 N																				
s = 0.10 m (chosen)																				

# Application Examples

## SCS45EU

### Controlled emergency stop

ACE safety shock absorbers protect precision assembly jigs for the aircraft industry. The basic mount of this coordinate measuring machine for the production of parts in the aircraft industry is made of granite and must not be damaged. To avoid damage from operating errors or mishandling, all movement axes were equipped with safety shock absorbers of the type SCS45-50EU. If the turntables malfunction the safety shock absorbers decelerate the loads before expensive damage can occur to the granite measuring tables.



Optimally protected turntable

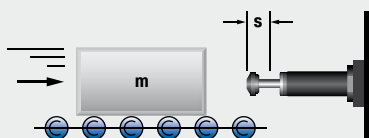

## SCS33EU, SCS45EU

### High-level protection of linear modules

Safety shock absorbers produced by ACE are installed in the top linear system models of one of the most prestigious companies in the field of drive and control technology. Their job: to protect the z-axis from damage caused by uncontrolled movements. Various safety dampers are used for different load ranges. Tests have shown that, in the worst case, a collision speed of up to 5 m/s might occur. To be on the safe side, the interpretations were based in all cases on a slightly higher value.



For protecting equipment and modules such as these, the SCS series from ACE is the ideal solution in the emergency stop sector  
Roth GmbH & Co. KG, 90411 Nürnberg, Germany and Bosch Rexroth AG, 97816 Lohr am Main, Germany

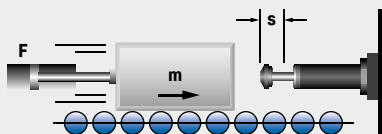



**SDP160EU**

**Customized buffer beam dampers**

Driving into lock gates should be specifically facilitated when navigating through Dutch river locks. That is why ACE developed special dampers, based on existing safety shock absorbers but with optimized characteristics, a fixed stop and a stroke of 800 mm. These are able to absorb 500,000 Nm, which means they can cope with fully loaded ships and also the mechanical impacts resulting from water movement. To return to the initial position, the safety shock absorbers operate on the same nitrogen-based principle as the gas springs produced by the damping specialists in Langenfeld.

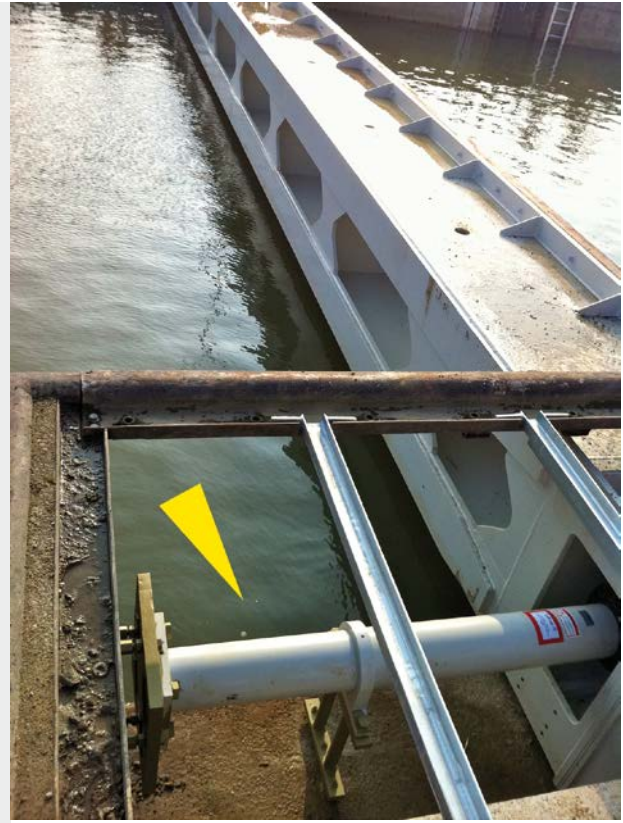
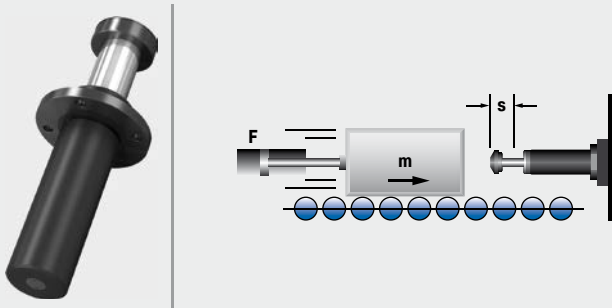

Heavy safety shock absorbers, which are specially designed for this application, are able to brake in lock masses of up to four million kg  
Mourik Limburg BV, 6101 AJ Echt, Netherlands

**SDH38EU**

**Safe driving to the end positions**

The aim was to protect a driving simulation capsule on two of its eight axes. The demands placed on a potential emergency stopper were high because it was clear that its failure would lead to massive damage to the complete construction as well as to the capsule. Even the possibility of damage to the health of the test personnel could not be ruled out and was taken into consideration in a diverse range of mass-speed combinations. Two ACE safety shock absorbers now safely contain destructive forces, e.g. during power outages, and eliminate high risks.

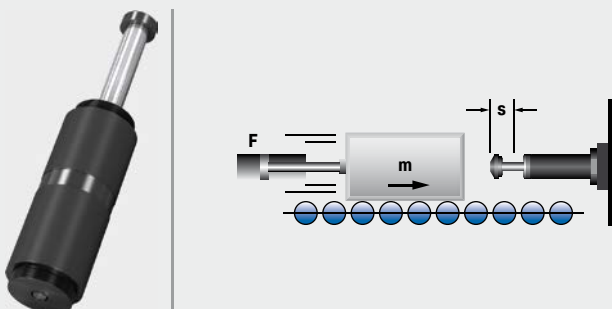

ACE safety shock absorbers protect end positions in two axes of a driving simulator  
Bosch Rexroth BV, Boxel 5281 RV, The Netherlands  
and University of Stuttgart - FKFS, 70569 Stuttgart, Germany

Issue 07.2017 – Specifications subject to change